

SV451 Microwave

Manual for Installation, Use and Maintenance

CDA





Contence Page

2-3	Important
4	How your appliance works
5	Your microwave
6	Fitting Out Your Appliance
7	The Control Panel and The Display
8-9	General Settings and Use
10	Quick guide
11-24	Programmes
25	Cleaning and Maintenance
26	Installation
27	Mains Electricity Connection

Important

This appliance must only be used for the purpose for which it is intended, i.e. domestic cooking, defrosting and reheating foods. Any other use could be dangerous and may lead to premature failure of the appliance.

The CDA Group Ltd cannot be held responsible for injuries or losses caused by incorrect use or installation of this product. Please note that CDA reserve the right to invalidate the guarantee supplied with this product following incorrect installation or misuse of the appliance.

It is dangerous for anyone other than a qualified person to perform maintenance or repair that requires the removal of the cover providing protection against exposure to microwave power.

User information:

- Ovens become hot during and immediately after use. Ensure you do not touch the heating elements located inside the appliance.
- The oven door can become very hot during operation.
- After use, please ensure that the appliance is switched off.
- Keep children away from the appliance when in use, and immediately after use.
- Keep the oven door closed when in use.

Appliance information:

Please enter the details on the appliance rating plate below for reference, to assist CDA Customer Care in the event of a fault with your appliance and to register your appliance for guarantee purposes.

Appliance Model

Serial Number

CE Declarations of Conformity:

This oven has been designed, constructed and marketed in compliance with safety requirements of EEC Directive 2006/95/EEC (Low voltage) and requirements of EMC Directive 2004/108/EEC.

This appliance has been manufactured to the strictest standards and complies with all applicable legislation, including Electrical safety (LVD) and Electromagnetic interference compatibility (EMC). Parts intended to come into contact with food conform to EEC/89/109.4

IMPORTANT INFORMATION FOR CORRECT DISPOSAL OF THE PRODUCT IN ACCORDANCE WITH EC DIRECTIVE 2002/96/EC.

At the end of its working life, the product must be taken to a special local authority waste collection centre or to a dealer providing appliance recycling services. Disposing of a household appliance separately avoids possible negative consequences for the environment and health. It also enables the constituent materials to be recovered, saving both energy and resources. As a reminder of the need to dispose of household appliances separately, the product is marked with a crossed-out wheeled dustbin. 

Important

- Read the user instructions carefully before using the appliance for the first time.
- Do not allow children near the oven when in use.
- Do not perform maintenance or cleaning of the oven without first switching off the electricity supply. If the oven has recently been used, allow to cool.
- Clean the appliance regularly.
- Remove spills as soon as they occur.
- Do not use abrasive cleaners or powders that will scratch the surface of the enamel.
- Do not allow vinegar, coffee, milk, saltwater, lemon or tomato juice to remain in contact with enamel parts. Check the door seal and door frame regularly to ensure they are not damaged.
- Do not attempt to repair the internal workings of your oven.

Only open the door using the handle

The microwave will not function if the door is not closed correctly.

The internal light will switch off automatically three minutes after the door is opened.

To eliminate moisture, this appliance is equipped with a delayed cooling function. The cooling fan will continue to run after the end of the programme and will stop automatically when it is no longer required.

It is possible to adjust the cooking time during cooking. This option is not available on the preset defrost programmes.

This appliance is designed to operate on all functions with the door closed.

Never operate the microwave when empty or without the turntable in place to prevent damage to your appliance.

Do not tamper with the openings on the lock on the front of the appliance. This could damage the appliance and may not be covered by the warranty.

Do not cook food or liquids in sealed containers as there is a risk they may explode. This includes baby bottles with the teat in place.

Baby milk and baby food must be stirred thoroughly after cooking and the temperature checked before consumption to ensure even temperature distribution and to prevent injury.

Heating liquids in the microwave can cause sudden or delayed eruption, so care must be taken when handling their containers.

Do not cook eggs in their shells or whole hardboiled eggs in the microwave as there is a risk they may explode, even after cooking has ended.

When heating small quantities of food (e.g. a sausage or a slice of bread), place a glass of water next to the food for best results.

Excessive cooking times may dry out or burn food. Do not use the recommended cooking times for a conventional oven when cooking in your appliance.

Cover food with plastic microwave-safe food wrap or an inverted plate before cooking.

Use only microwave safe utensils. The use of metallic cookware, forks, spoons, knives or metal staples and fasteners for defrosting bags is not recommended.

Always use oven gloves to remove dishes from the oven. Some dishes will absorb the heat from the food and so are hot to the touch after cooking.

When cooking or reheating items in paper or plastic containers, you should monitor the microwave contents due the risk of combustion.

If you see smoke inside the microwave, stop the programme, switch off the power at the plug and leave the door closed to stifle any flames inside the cavity.

How your appliance works

The microwaves used for cooking are electromagnetic waves. They are commonly found in our environment in the form of radio waves, light and infrared rays.

Their frequency is in the 2450 MHz range.

The microwaves are reflected by metals, but travel through all other materials. They are absorbed by water, fat and sugar molecules.

When food is exposed to microwaves, its molecules begin moving rapidly, causing it to heat up.

The penetration depth of the waves into the food is approximately 2.5 cm. If the food is thicker, the centre of the food will be cooked by conduction, as in conventional cooking.

Please note: The microwaves cause a simple thermal phenomenon within food and are not harmful to health.

Using the touch control

The touch controls should be used with the flat of your finger, rather than the fingertip.

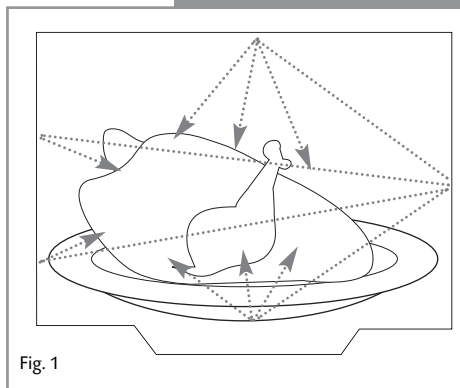

Fig. 1

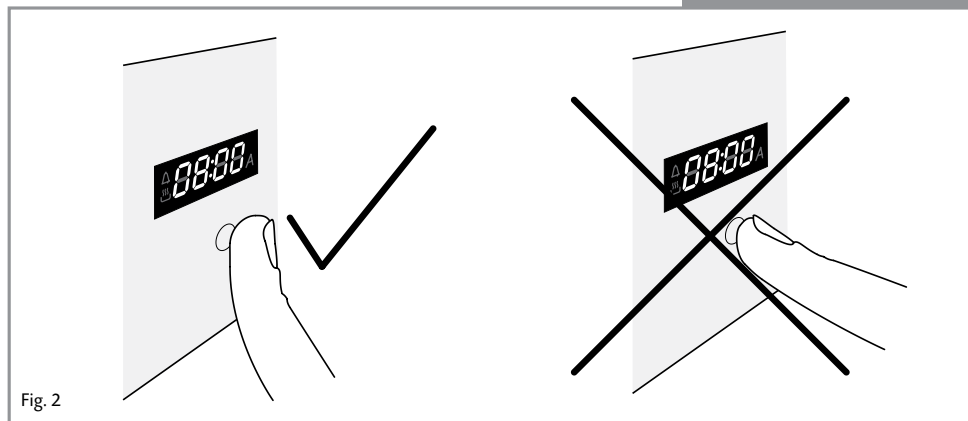

Fig. 2

Your microwave

Control Panel

- A - Control panel
- B - Microwave cavity
- C - Turntable
- D - Door handle

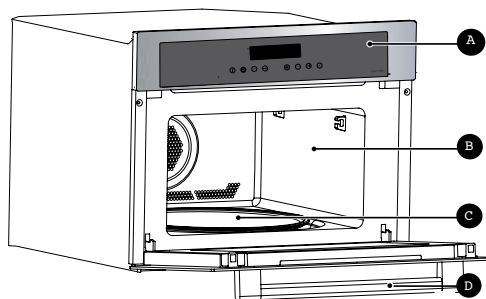



Fig. 3

Turntable Operation

The turntable (A in figure 4) rotates to allow food to be cooked evenly without needing to stop the programme and turn the food by hand. It rotates in either direction. The turntable can also be used as a cooking dish. To remove it after use, lift it using the access areas provided in the base of the cavity.

If the turntable does not turn, first check that it has not been turned off (touch  - only on microwave and combination programmes), then ensure all parts of the turntable and mechanism are correctly in position. Never try to rotate the turntable by hand. This can damage the drive mechanism (B in figure 4) and may invalidate your warranty. You should also check there is nothing obstructing the guide wheels (C in figure 4).

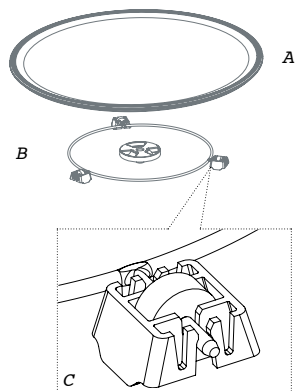

Fig. 4

Fitting Out Your Appliance

1. Side racks

The side racks allow three different cooking heights for the drip tray and shelf (figure 5).

When cooking using the grill or combination grill programmes, use the drip tray or shelf at height 1 for thick foods such as roasts, and at height 3 for thin foods such as bacon or chops.

When cooking using the fan oven or combination fan oven programmes, use the drip tray or shelf at height 1 or 2 depending on the dish.

To put the side racks into place, hold the side rack at an angle (figure 6), locate the top of the side rack in the hooks at front and back of each side of the cavity, then lower the rack to vertical.

2. Drip tray

The enamel drip tray can be used for baking cakes or placed underneath the shelf to collect the juices from grilling (figure 7). Avoid placing roasts or meats directly in the drip tray, as this will cause significant splattering on the oven walls.

Never use the drip tray on microwave or combination programmes.

For the best performance, ensure the drip tray is centred on the side racks – do not push the tray all the way to the back of the cavity.

3. Shelf

The metal shelf can be used for toasting, browning and grilling.

The shelf can be used on microwave or combination programmes. If the food to be cooked is in an aluminium container, this should be placed on a plate on the shelf. To not leave metal cookware in contact with the shelf when the microwave is on.

4. Glass tray

The glass tray can be used as a cooking dish, half-filled with water as a bain-marie/double boiler, or as an alternate to the enamel drip tray.

For the best performance, ensure the drip tray is centred on the side racks – do not push the tray all the way to the back of the cavity.

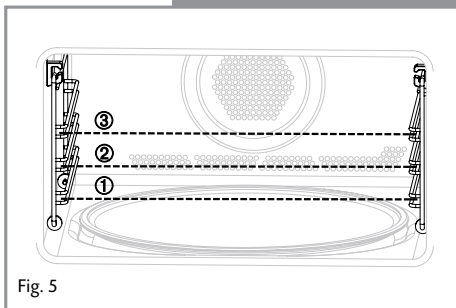

Fig. 5

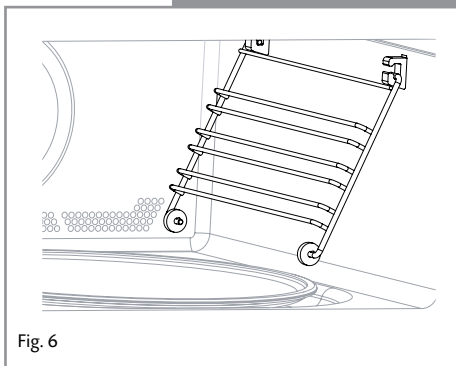

Fig. 6

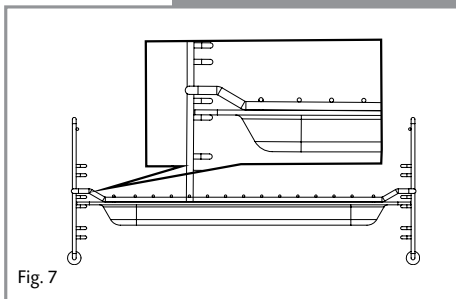
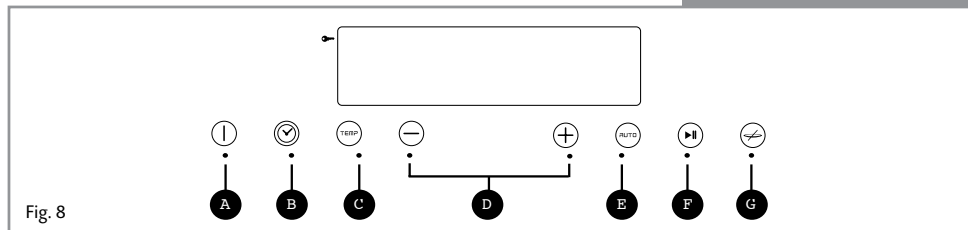

Fig. 7

The Control Panel



A	Power	This key switches on the microwave or cancels the programme
B	Clock	This key activates the timer selection.
C	Temperature	This key activates the temperature selection.
D	Plus and Minus	These keys select the programme type, increase or decrease the times, power levels and temperatures.
E	Auto	This key activates the automatic cooking programmes.
F	Start/Pause	This key starts and pauses cooking, and also switches the childlock on and off.
G	Turntable stop	This key switches off the turntable in any of the microwave or combination programmes.

The Display

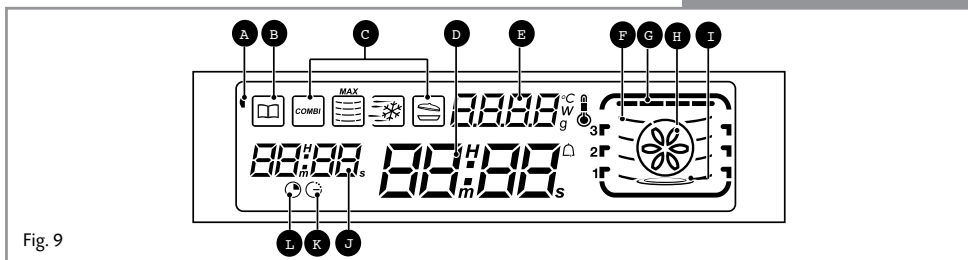

A	Childlock on
B	Automatic cooking programme
C	Cooking programme selected (Combination, Full power Microwave, Defrost, Keep hot)
D	Clock display
E	Temperature/power level/weight of food
F	Microwave programme
G	Grill programme
H	Fan oven programme
I	Turntable switched on (both lines show) or switched off (only outline shows)
J	Timer display
K	Delayed programme set
L	Cooking time set

General Settings and Use

Clock

To set the clock when the time is flashing (for example, at first switch on) touch \ominus or \oplus until the correct time shows on the display, then touch Ⓜ to confirm the selection. There will be two beeps to confirm the selection and the clock will stop flashing.

To set the clock once the time has been set (when the clock is not flashing) touch Ⓛ , then touch Ⓜ twice until the clock flashes. Touch \ominus or \oplus until the correct time shows on the display, then touch Ⓜ to confirm the selection. The microwave will beep twice to confirm the selection and the clock will stop flashing.

Childlock

This appliance is equipped with a childlock to prevent accidental use. For safety reasons the Ⓛ key will work to switch the appliance off when the childlock is set.

To switch the childlock on or off, touch and hold Ⓜ for approximately five seconds until Ⓛ shows in the top left corner of the display (as shown in figure 10) and there are two beeps to confirm the selection.

When the childlock is on, Ⓛ shows in the display and Ⓜ will flash if any key is touched.

Contrast adjustment

To adjust the contrast on the display, touch Ⓛ and then touch and hold Ⓜ for approximately seven seconds until -CO- shows on the display as shown in (figure 11). Touch \ominus or \oplus until the contrast is at the required level, then touch Ⓜ to confirm the selection.

Minute minder

This appliance is equipped with a minute minder that can be used when there is no programme selected. The minute minder can run for a maximum of 60 minutes. To set the minute minder, touch Ⓛ and then Ⓜ . Touch \ominus and \oplus until the required time shows on the display and touch Ⓜ to start the minute minder.

The display will show the current time and Ⓛ . At the end of the countdown, Ⓛ will flash and the appliance will beep intermittently for approximately 80 seconds. To stop the end of timer alerts before that time, touch Ⓛ .

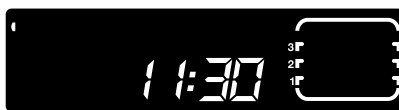



Fig. 10



Fig. 11

General Settings and Use

Turntable stop

If the food to be cooked or defrosted is too big to allow the turntable to turn, touch  to stop the turntable. This option is only available on microwave and combination programmes. The display will show two circles when the turntable is switched on (figure 12), and one circle when it is switched off (figure 13).

To switch the turntable back on, touch  again.

Please note: When the turntable is stopped, you must ensure the food is turned and stirred regularly during the programme.

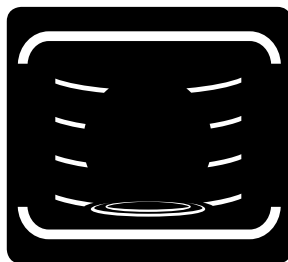

Fig. 12

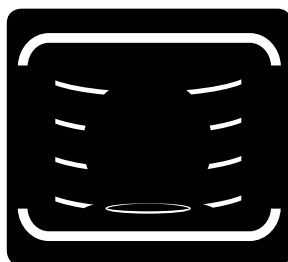

Fig. 13

Two level cooking

You can cook on two levels at once on the 500W microwave programme. One plate should be on the turntable and the other plate on the shelf at height 3.

The programme times shown below are examples of foods stored at room temperature or refrigerated foods.

Food type	Quantity	Cooking time
Foods with an even texture (purée, peas, celery, etc.)	Two 200 g plates	4 - 6 minutes
Foods with an uneven texture, such as casseroles, stews, ravioli etc.	Two 300 g plates	6 - 8 minutes

Quick guide

Touch ①

Touch ⊖ or ⊕ until the required programme shows on display.

Touch ⊕ to confirm the programme.

Touch ⊖ to activate temperature selection (where applicable), touch ⊖ or ⊕ until the required temperature shows on display, then touch ⊕ to confirm the temperature selection.

To pause a programme which is running, either touch ⊕ or open the door. To restart the programme, ensure the door is closed and touch ⊕.

To adjust the cooking time during the programme, touch ⊕ to activate timer selection, touch ⊖ or ⊕ until the required time shows on display, then touch ⊕ to confirm the timer selection. It is not possible to adjust the timer on the defrost (d02-d04) programmes.

To cancel a programme, touch ①.

At the end of the programme, there will be three beeps.

The current time will show on the display one minute after the programme ends.

Programme	Preset	Power/Temperature available	Maximum cooking time
Microwave full power	1000W	1000W only	60 minutes
Microwave adjustable power	800W	100-1000W	60 minutes
Defrost	D01	Four different defrost programmes (see Defrost section)	
Fan oven	200°	50-250°	9 hours 59 minutes
Full grill	3	1 – 3	9 hours 59 minutes
Half grill	2	1 – 3	9 hours 59 minutes
Combination fan oven and microwave	200°	50-250° in 10° increments	9 hours 59 minutes
Combination fan oven and full grill	3	1 – 3	9 hours 59 minutes
Combination fan oven and half grill	2	1 – 3	9 hours 59 minutes
Keep hot function	80°	35-100°	9 hours 59 minutes



Programmes

1. 1000W max microwave programme

Touch 

Touch  once so 1000W and  and show on the display.

Touch  to confirm the programme.



The cooking time is preset at 30 seconds. To adjust this, touch  or  until the required time shows on the display, then touch  to confirm the selection. The programme will start.





2. Variable power level microwave programme

Touch 

Touch  twice so 800W and  and show on the display.

Touch  to confirm the programme.

The power level is preset at 800W. To adjust this, touch  or  until the required power level shows on the display, then touch  to confirm the selection.

Touch  to activate timer selection, touch  or  until the required time shows on display, then touch  to confirm the timer selection. The programme will start.

MAX

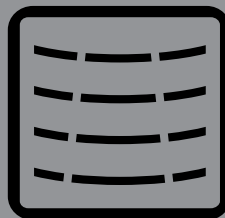
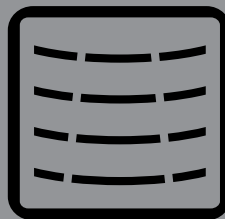

Power level	Use
1000 W / 900 W	Quick reheating of beverages, water and dishes containing a large quantity of liquid. Cooking dishes containing lots of water (soups, sauces, tomatoes, etc.)
800 W / 700 W	Cooking fresh or frozen vegetables.
600 W	Melting chocolate.
500 W	Cooking fish and seafood. Reheating on two levels. Cooking dried vegetables at a low heat. Re-heating or cooking delicate egg-based foods.
400 W / 300 W	Cooking dairy products, jams on a low heat.
200 W	Manual defrosting. Softening butter and ice cream.
100 W	Defrosting pastries containing cream.

Programmes

3. Defrost programmes

To defrost using your microwave, follow the steps below: Touch \odot

Touch \oplus three times so d01 and $\frac{30}{200}$ show on the display.

Touch \odot to confirm the defrost programme.

Touch \ominus or \oplus until the required defrost programme (d01-d04) shows on the display, then touch \odot to confirm the selection.

For d01, the programme time flashes on the display. For d02-d04 the weight will flash on the display (100g is the preset weight, and also the minimum available).

Touch \ominus or \oplus until the required time (d01) or weight (d02-d04) shows on the display, then touch \odot to confirm the selection. The programme will start.

For d02-d04, the microwave automatically calculates the defrost time from the programme type and the weight.

This microwave is equipped with four different defrost programmes, as detailed in the table.



Programme number	Type of food to defrost	Weight options available
d01	Any other food or weight not available in programmes d02-d04. This programme requires that you set the required defrosting time and runs at 200W.	n/a
d02	Meat, poultry, fish and vegetables	100-2000g
d03	Bread	100-500g
d04	Pre-cooked foods	100-2000g

Please note

Foods with a weight over 350g should be turned halfway through defrosting. The microwave will beep to remind you to turn the food over. Once the food is turned, close the microwave door and touch \odot to restart the defrosting programme. Small cuts of meat or fish can be cooked immediately after defrosting.

Larger cuts, such as meat joints or whole fish, may still be slightly frozen at the end of the defrost programme. You should let them rest for at least the same length of time again as the defrost programme so that they reach an even temperature. If the food to be defrosted is too big to allow the turntable to turn, touch \odot to stop the turntable. If the turntable is switched off, ensure the food is stirred regularly during defrosting.

Defrost meat and fish by placing it on an upturned saucer on top of a plate to allow the juices to flow out. If the juices remain in contact with the food, it may overheat.

Food should be removed from its packaging prior to defrosting. Ensure any metal packaging is removed.

Never refreeze defrosted food, unless it has been cooked after defrosting.

Programmes

Defrosting times

Foods covered with ice crystals will take longer to defrost. You should increase the defrosting time accordingly.

The defrost time depends on the shape, size, initial temperature and quality of the food.



Defrosting guide

Food	Quantity	Time	Recommendations
Flaky or short crust pastry	400 g	1 - 3 minutes	Place on absorbent paper and turn over half way through.
Scallops	500 g	5 - 7 minutes	Place on a plate and stir half way through.
Shelled prawns	100 g	1 - 2 minutes	
Whole pink prawns	200 g	2 - 4 minutes	
Crayfish/tiger prawns (10)	500 g	6 - 8 minutes	

Food	Quantity	Time
Whole fish/darns/fillets/ steaks	100 g	1 - 2 minutes
	200 g	3 - 5 minutes
	400 g	5 - 7 minutes
	500 g	7 - 9 minutes
	750 g	12 - 14 minutes
	1000 g	17 - 19 minutes
Turkey/ pork / veal / beef / poultry Roasted / sliced / cubed / etc...	100 g	1 - 2 minutes
	200 g	3 - 5 minutes
	400 g	5 - 7 minutes
	500 g	7 - 9 minutes
	750 g	12 - 14 minutes
	1000 g	17 - 19 minutes
	1250 g	23 - 25 minutes
	1500 g	28 - 30 minutes
	1750 g	34 - 36 minutes
2000 g	39 - 41 minutes	
Cauliflower / broccoli / carrots / mushrooms / diced mixed vegetables / etc...	500 g	7 - 9 minutes
	750 g	12 - 14 minutes
	1000 g	17 - 19 minutes
Strawberries	250 g	7 - 9 minutes
Raspberries / cherries	250 g	6 - 8 minutes
Gooseberries / blueberries / blackcurrants	250 g	5 - 7 minutes

Programmes

4 Fan oven programme





The fan oven programme allows you to cook and brown foods just as you would in a traditional oven. The cooking temperature can be set between 50-250° in 10° increments.





Place the food on the shelf on either the first or second height.





Touch 



Touch  four times so the fan oven programme shows on the display.

The temperature is preset to 200°.

To change the temperature, touch  to activate temperature selection, touch  or  until the required temperature level shows on display, then touch  to confirm the selection.

To set or adjust the cooking time, touch  to activate timer selection so the timer display shows , touch  or  until the required time shows on display, then touch  to confirm the timer selection.

To set a delayed programme, touch  twice to activate timer selection so the timer display shows  and the time the programme is due to end (current time + cooking time), touch  or  until the required time shows on display, then touch  to confirm the timer selection. The timer display will then show planned time for the programme to end.

To start the programme touch . If a delayed programme is set, the microwave will go on to standby and  will show on the display until the programme starts.

Once the required temperature is reached, the upper bars on the temperature indicator on the display  will stay lit there will be three beeps, a pause, and a further three beeps to confirm the oven is at the required temperature.

Please note:

On fan oven programmes, use heat resistant dishes, for example pyrex, and protect your hands when removing dishes after cooking.

Do not defrost food immediately after using the fan oven programme. Wait approximately ten minutes for the appliance to cool for best results.

It is possible to cook on two levels at once, for example to cook two apple tarts, place one on the glass drip tray on the first height, and the other on the shelf on the third height. Ensure that you swap the two dishes halfway through the cooking time for even results.

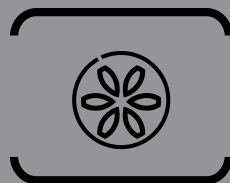

Programmes

Fan oven guide

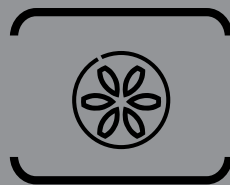

Food	Temperature	Cooking height	Cooking time
Meat			
Roast pork (1 kg)	160°C	On the shelf at height 2	90 min
Roast veal (1 kg)	180°C	On the shelf at height 2	70 - 75 min
Roast beef (1 kg)	220°C – preheat required	On the shelf at height 2	38 - 40 min
Lamb (leg, shoulder, 1.5 kg)	180°C	In the drip tray at height 2	50 - 60 min
Poultry (1.2 kg)	180°C	On the shelf at height	170 - 75 min
Large poultry	180°C	On the shelf at height 1	90 - 120 min
Rabbit	230°C	In the drip tray at height 2	40 - 45 min
Fish (1,2 kg)			
Whole (snapper, salmon, hake)	180°C	In the drip tray at height 2	35 - 45 min
Vegetables			
Potatoes au gratin	180°C	On the shelf at height 2	50 - 55 min
Lasagne	180°C	On the shelf at height 2	40 - 45 min
Stuffed tomatoes	180°C	On the shelf at height 2	45 - 55 min
Pastries			
Savoie cake	150°C	On the shelf at height 2	35 - 45 min
Genovese	150°C	On the shelf at height 1	35 - 45 min
Genovese roll	150°C	In the drip tray at height 2	20 – 25 min
Cake	160°C	On the shelf at height 1	40 - 50 min
Biscuits	180°C	In the drip tray at height 2	18 – 22 min
Cookies	160°C	In the drip tray at height 2	20 – 25 min
Cream	160°C	On the shelf at height 2	35 - 45 min bain-marie / double boiler
Madeleines	170°C	In the drip tray at height 2	20 - 30 min
Pound cake	170°C	On the shelf at height 2	40 – 50 min
Cheesecake	170°C	On the shelf at height 1, springform 26cm diameter mould	65 – 75 min

Fan oven guide continues on next page...

Programmes

Fan oven guide

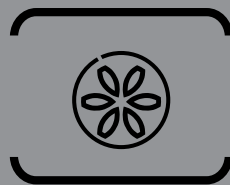

Food	Temperature	Cooking height	Cooking time
Pastries			
Kugelhopf	180°C	On the shelf at height 1, in a special mould	45 – 50 min
Choux pastry	180°C	In the drip tray at height 2	35 – 40 min depending on size
Short crust tart	200°C	On the shelf at height 2	40 – 45 min
Puff pastry crust tart	250°C – preheat required	On the shelf at height 2	30 – 40 min
Miscellaneous			
Pâté in terrine (1 kg)	190°C	On the shelf at height 1	90 min
Savoury tarts	170°C	On the shelf at height 2 in a 20 cm mould	55 - 65 min
Stews and casseroles	160°C	On the shelf at height 1, depending on the dish.	90 - 180 min
Bread (500 g flour)	220°C – preheat required	On the shelf at height 2	25 - 30 min

Programmes

5 Full Grill

6 Half Grill

You can use the grill programmes to cook or brown gratinated foods or meats. This appliance has both full grill and half grill programmes dependent on the amount of food to be cooked. Each grill programme has three different power levels, 3 for full heat, 2 for medium heat, 1 for low heat. Level 3 is recommended for grilling meat and fish, and 2 or 1 for browning and crisping more delicate foods. For best results, you can use the combined microwave and grill functions on levels 2 or 1.





To grill:





Place the food either on shelf height 2 or 3, depending on the height of the food or cookware, and place the drip tray directly underneath.





Touch 



Touch  five or six times so the full or half grill programme show on the display.

The full grill is preset to level 3, the half grill is preset to level 2.

To change the temperature, touch  to activate temperature selection, touch  or  until the required temperature level shows on display, then touch  to confirm the selection.

To set a cooking time, touch  to activate timer selection so the timer display shows , touch  or  until the required time shows on display, then touch  to confirm the timer selection.

To set a delayed start time, touch  twice to activate timer selection so the timer display shows , touch  or  until the required time shows on display, then touch  to confirm the timer selection.

To start the programme touch . If a finish time is set, the appliance will go onto standby and  will show on the display until the programme starts.

Food	Quantity	Time
Sausages or black pudding (these should be pricked with a fork)	4 – 6	22 - 30 minutes
Pork chops	4	27 - 32 minutes
Lamb chops	4	15 - 17 minutes
Beef rib	800 g	23 - 25 minutes
Smoked belly pork	4 – 6 slices	18 – 25 minutes

Please note:

Ensure you turn the food over half way through cooking.

On grill programmes, use heat resistant cookware, for example pyrex or ceramic, and protect your hands when removing dishes after cooking.



Programmes

7. Combination Fan Oven and Microwave programme





The combination fan oven and microwave programme allows you to cook and brown foods just as you would in a traditional oven but much more quickly than with the fan oven programme. The cooking temperature can be set between 50-250° in 10° increments.





Place the food on the shelf on either the first or second height,





Touch 



Touch  seven times (or  four times) so the combination fan oven and microwave programme and  shows on the display.

The temperature is preset to 200°.

To change the temperature, touch  to activate temperature selection, touch  or  until the required temperature level shows on display, then touch  to confirm the selection.

To set or adjust the cooking time, touch  to activate timer selection so the timer display shows , touch  or  until the required time shows on display, then touch  to confirm the timer selection.

To set a delayed programme, touch  twice to activate timer selection so the timer display shows  and the time the programme is due to end (current time + cooking time), touch  or  until the required time shows on display, then touch  to confirm the timer selection. The timer display will then show the set end time.

To start the programme touch . If a finish time is set, the microwave will go on to standby and  will show on the display until the programme starts.

Please note:

Never preheat the microwave on combination programmes.

Do not use metal cookware on combination programmes.

On fan oven programmes, use heat resistant dishes, for example pyrex, and protect your hands when removing dishes after cooking.

Do not defrost immediately after using the fan oven programme. Wait approximately ten minutes for the appliance to cool for best results.

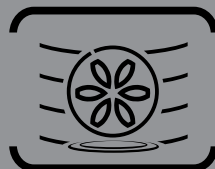

Programmes

It is possible to cook on two levels at once, for example an 800g roast and 800g potatoes au gratin at 170° for 55 minutes. Place the roast on the glass drip tray at the third height, and the potatoes on the turntable.

Do not baste roasts prior to cooking to reduce smoke and grease splashes. After the roast is cooked, season the joint, wrap it in aluminium foil and let it rest for ten minutes to make the roast juicier.

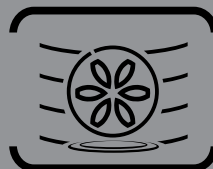

Food	Quantity	Programme	Time	Recommendations
Lamb shoulder (boned and tied)	1300 g	MW + Fan oven 200°	32- 37 minutes	In the drip tray at height 2
Entrecote	800 g	MW + Fan oven 200°	23 – 28 minutes	In a dish, on the grid at height 2
Chicken, guinea fowl	1200 g	MW + Fan oven 200°	35 – 40 minutes	In a dish, on the grid at height 1
Roast turkey	800 g	MW + Fan oven 180°	32 – 37 minutes	In a dish on the grid at height 2
Roast pork	1200 g	MW + Fan oven 180°	47 – 52 minutes	In a dish on the grid at height 2
Roast veal	1000 g	MW + Fan oven 180°	37 - 42 minutes	In a dish on the grid at height 2

Programmes

8 Combination Full Grill and Microwave



9 Combination Half Grill and Microwave

You can use the combination grill and microwave programmes to cook or brown gratinated foods or meats quickly. This microwave has both full grill and half grill programmes dependent on the amount of food to be cooked. Each combination grill and microwave programme has three different temperature levels, 3 for full heat, 2 for medium heat, 1 for low heat.





To grill using your microwave, follow the steps below:





Place the food either on shelf height 2 or 3, depending on the height of the food or





cookware, and place the drip tray directly underneath. Touch 

Touch  eight or nine times (or  three times or twice) so the combination full or half grill and microwave programme and  show on the display.

The full grill is preset to level 3, the half grill is preset to level 2.

To change the temperature, touch  to activate temperature selection, touch  or  until the required temperature level shows on display, then touch  to confirm the selection.

To set a cooking time, touch  to activate timer selection so the timer display shows , touch  or  until the required time shows on display, then touch  to confirm the timer selection.

To set a delayed start time, touch  twice to activate timer selection so the timer display shows , touch  or  until the required time shows on display, then touch  to confirm the timer selection.

To start the programme touch . If a finish time is set, the microwave will go onto standby until the programme starts.

Please note:

Ensure you turn the food over half way through cooking.

On the combination grill and microwave programmes, use microwave-safe, heat resistant cookware, for example ceramic, as these cause less splashes than glass, and protect your hands when removing dishes after cooking.

Do not baste roasts prior to cooking to reduce smoke and grease splashes. After the roast is cooked, season the joint, wrap it in aluminium foil and let it rest for ten minutes to make the roast juicier.

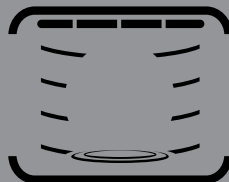
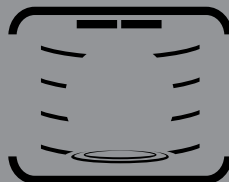



Food	Quantity	Programme	Time
Lamb shoulder (boned and tied)	1300 g	MW + Half grill on 3	40 - 45 minutes
Entrecote	800 g	MW + Half grill on 3	18 - 23 minutes
Chicken, guinea fowl	1200 g	MW + Full grill on 3	25 - 27 minutes
Roast turkey	800 g	MW + Half grill on 3	27 - 32 minutes
Roast pork	1000 g	MW + Half grill on 3	35 - 40 minutes
Roast veal	1200 g	MW + Half grill on 3	50 - 55 minutes

Programmes



10. Keep hot programme





This programme will run at a temperature between 35 and 100° to keep food warm.

Touch 

Touch  once (or  ten times) so 80° and  show on the display.

Touch  to confirm the programme.

Touch  or  until the required temperature shows on the display, then touch  to confirm the selection. The programme will start.

If an end time is required, touch  and then touch  or  until the required duration shows on the display, then touch  to confirm the selection.

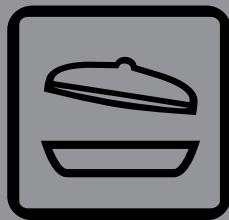

Programmes

Auto Cook Programmes

This microwave has 12 preset automatic cooking programmes which specify cooking time and mode based on the food type and weight. The programmes are listed below along with detailed programme information and recommendations



Programme number	Food type	Weight of food	Function used
P01	Refrigerated ready meals	100-1000g	Microwave
Remove the product from its packaging and place in a suitably sized, heat resistant microwave safe dish. For best results, cover with plastic microwave food wrap or an inverted plate. Place the dish on the turntable. Wait for two minutes after the end of the programme to allow the heat to distribute evenly across the food.			
P02	Fresh pizza		Fan oven
Remove the pizza from its packaging and place it directly on the shelf at height 2.			
P03	Frozen pizza	125-650g	Combination grill and microwave
Remove the pizza from its packaging and place it directly on the shelf at height 2.			
P04	Roast pork	500-2000g	Combination fan oven and microwave and combination grill and microwave
P05	Roast beef		
Remove the meat from the fridge and allow it to come up to room temperature for one hour before cooking. Place the dish on the shelf at height 2.			
P06	Poultry	500-2000g	Combination fan oven/grill and microwave
Before cooking, pierce the skin to avoid spitting, then add oil, salt and pepper and sprinkle with herbs if required. To cook a whole chicken place the dish on the shelf at height 1. Chicken legs (up to 900g) may be placed directly on the glass drip tray, on the shelf at height 2. Allow the chicken to rest in the oven for five minutes after the end of the programme before serving.			
P07	Fish	100-1000g	Microwave
All types of fresh fish can be cooked in the microwave. Fish fillets and steaks can be cooked in one piece, but prior to cooking whole fish, you are recommended to score the thickest parts for the best results. Place the fish in a round or oval microwave safe dish, add two to three tablespoons of water, lemon juice or white wine and then cover with plastic microwave food wrap or an inverted plate. Place the dish directly on the turntable. Season after cooking.			

Programmes

Auto Cook Programmes

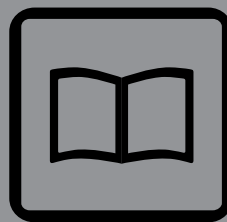

Programme number	Food type	Weight of food	Function used
P08	Fresh fibrous vegetables, e.g. Brussels sprouts, cabbage, carrots etc.	100-1000g	Microwave
P09	Vegetables containing a lot of water, e.g. courgettes, leek, finely sliced potatoes, spinach broccoli		
P10	Frozen vegetables		
<p>For fresh vegetables, place them in a lidded dish and add the following amounts of water: Up to 200g - 2 tablespoons; 200 – 500g – 50ml; 500 – 1000g – 100 ml. Place the dish directly on the turntable. Midway through cooking, 'turn' will show on the display and the microwave will beep to remind you to stir the food. Add fat and season if desired. Wait for two minutes after the end of the programme to allow the heat to distribute evenly across the food.</p>			
P11	Tarts	27-30cm diameter, 35 minute fixed time	Combination fan oven and microwave
P12	Quiche		
<p>Use a heat resistant, microwave safe tart mould, e.g. pyrex or porcelain. If using ready-made pastry, do not remove the grease-proof paper. Cut the excess paper to the dimensions of the dish. Place the mould on the shelf at height 2. Do not use a metal mould.</p> <p>For quiches, begin cooking as soon as the filling has been poured into the pastry case. Do not let the pastry soak or it will not cook properly.</p>			

Touch

Touch to activate the auto cook selection. P01 will show on the display.

Touch or until the required programme (P01-P12) shows on the display, then touch to confirm the selection.

The weight will flash on the display. Touch or until the weight of the food shows on the display, then touch to confirm the selection. The microwave will automatically set the cooking mode and time, and the programme will start.

Halfway through the programme, the microwave will beep once, and TURN will show on the display. Open the door, turn the food over, close the door and touch to continue the programme.

Programmes

Function suitability tests

The International Electrotechnical Commission, SC.59K, has established a standard for comparative performance tests conducted on various microwave ovens.

Below are the details of the function suitability tests performed in accordance with IEC/EN/NF EN 60705.

Test	Load	Approx. time	Power level / temperature	Cookware / Tips
Egg custard (12.3.1)	1000 g	16 - 18 min	500 W	Pyrex 227 On the turntable
	750 g	13 - 15 min		Pyrex 220 On the turntable
Savoie cake (12.3.2)	475 g	6 - 7 min	700 W	Pyrex 827 On the turntable
Meatloaf (12.3.3)	900 g	14 min	700 W	Pyrex 838 Cover with plastic film On the turntable
Defrosting meat (13.3)	500 g	11 - 12 min	200 W	On the turntable
Defrosting raspberries (B.2.1)	250 g	6 - 7 min	200 W	On a flat plate On the turntable
Potatoes au gratin (12.3.4)	1100 g	23 - 25 min	Combination full grill and microwave power level 2 or 3	Pyrex 827 On the turntable
Chicken (12.3.6)	1200 g	24 - 26 min	Combination full grill and microwave power level 3	Place on the shelf and drip tray Place on the first level Turn half-way through
		35 - 40 min	Combination fan oven and microwave 200°	In a glazed earthenware dish. Place on the shelf on the first level up from the bottom
Cake (12.3.5)	700 g	20 min	Combination fan oven and microwave 200°	Pyrex 828 Place on the shelf at height 1

Cleaning and Maintenance

IMPORTANT:

Always disconnect the appliance from the power supply before undertaking any cleaning or maintenance.

You should always allow the oven to cool fully after use before undertaking any cleaning or maintenance.

You should only use non-abrasive cleaners. Any abrasive cleaners (including Cif) will scratch the surface and could erase the control panel markings. You should not use cleaning products with a chlorine or acidic base.

Any spillages should be cleaned off immediately, especially any alkaline or acidic substances (lemon juice, vinegar etc.)

Stainless steel

Stainless steel can be effectively cleaned by simply using a dilute solution of water and mild detergent and drying to a shine with a clean cloth. Proprietary stainless steel cleaners are available. We recommend the CDA E-Cloth available from the CDA Sales Team for cleaning stainless steel surfaces.

Enamelled parts

All enamelled parts must be cleaned with a sponge and soapy water only, or other non-abrasive products. Suitable proprietary chemical cleaners may be used after first consulting with the manufacturer's recommendations and testing a small sample on the oven cavity.

Inside the oven

It is recommended that the interior of the oven be cleaned after every use using suitable products, especially if any spillage has occurred. The shelves, turntable and turntable support can be removed and washed by hand or in the dishwasher. Ensure the turntable support and turntable are replaced before use.

For stubborn stains, boil a cup of water in the oven for 2 to 3 minutes. Steam will soften the marks prior to cleaning. To remove odours from the oven, add some lemon juice to a cup of water, place the cup on the turntable and allow it to boil for a few minutes.

When used regularly, the grill element does not need cleaning as the intense heat will burn off any splashes. The interior ceiling may need regular cleaning, which should be done with warm water, detergent and a sponge. If the grill is not used regularly, it should be run for 10 minutes every month to burn off any splashes, in order to reduce the risk of fire.

PLEASE NOTE: Steam cleaners must not be used to clean this appliance.

Do not store flammable material in the oven.

Do not allow grease or food particles to build up around the door.

When correctly installed, your product meets all safety requirements laid down for this type of product. However, special care should be taken around the rear or the underneath of the appliance as these areas are not designed or intended to be touched and may contain sharp or rough edges that could cause injury.

The light bulb must only be replaced by authorised service personnel. In the event of light bulb failure, contact CDA Customer Care.

Installation

The appliance can be installed under a worktop or in a wall unit (open or closed) with the appropriate dimensions for recessed installation.

Do not use your appliance immediately after moving it from a cold location, as condensation may cause a malfunction. Wait approximately 1-2 hours before use.

Centre the oven in the unit so as to ensure a minimum distance of 10mm between the appliance and the surrounding unit. The material of the unit supporting the appliance must be heat resistant (or covered with a heat resistant material). For greater stability, attach the oven to the unit with two screws through the holes provided on the side panels.

If the appliance is to be installed under a worktop, ensure the top rail has been removed to provide free airflow around the product.

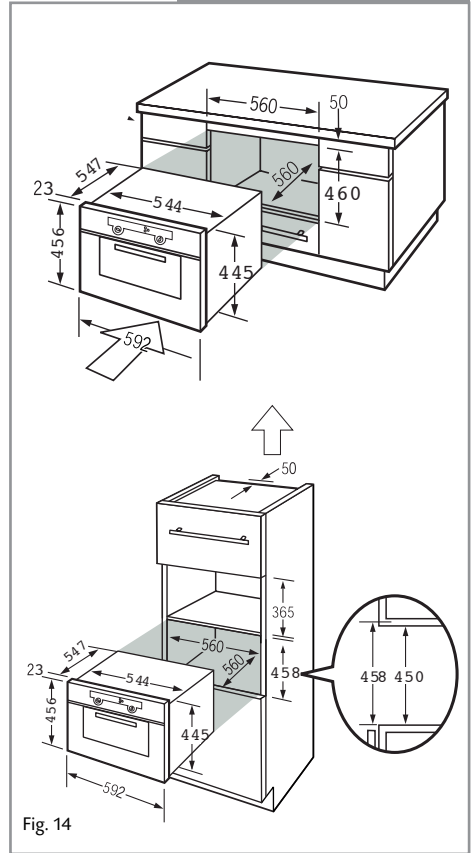

Mains Electricity Connection

Warning! This appliance must be earthed

We recommend that the appliance is connected by a qualified electrician, who is a member of the N.I.C.E.I.C. and who will comply with the I.E.E. and local regulations.

This appliance is intended to be connected to fixed wiring and is not suitable for connection to a 13A plug or 13A supply.

This appliance is intended to be connected to fixed wiring by a double pole switch, having a contact separation of at least 3mm in all poles. The switch must be positioned no further than 2m from the appliance.

This appliance is supplied with a 3 core mains cable; the wires are in accordance with the following code:

Green and Yellow = Earth

Blue = Neutral

Brown = Live

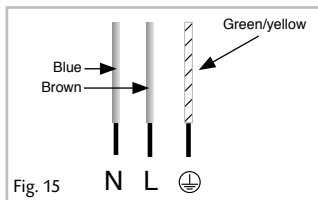

Please note:

- The mains cable must only be replaced by a qualified electrician or service engineer and must be of equivalent or better rating (i.e. 1.5mm², H05V2V2-F).
- The marking of the current rating of the fuse or circuit breaker protecting this appliance should be marked on the socket outlet (16A).
- Assembly and electrical connection should be carried out by specialised personnel.
- When installing this product we recommend you seek the help of another individual.
- The mains isolation switch must be accessible after installation.









To contact our Customer Care Department, or for Service,
please contact us on the details below.